

Progressive Scan CCD NETWORK CAMERA Quick Installation Guide

English | 繁中 | 簡中 | 日本語 | Français | Español | Deutsch | Português | Italiano | Türkçe | Polski | Русский



IP7151/IP7152

This guide describes the basic functions of IP7151/IP7152.
All detailed information is described in the user's manual.



Warning Before Install

- **Power off the Network Camera as soon as it is found smoking or smelt unusual.**



Contact your distributor when such cases happen.

- **Keep the Network Camera away from water. If the Network Camera is wet, power off immediately.**



Contact your distributor when such cases happen.

- **Do not place the Network Camera around the heat sources, such as television or oven.**

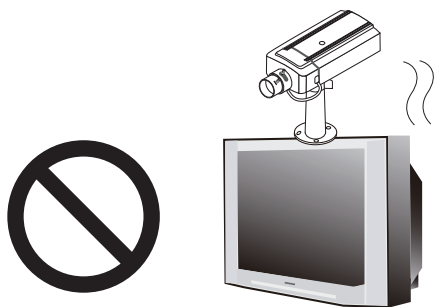

- **Refer to your user's manual for the operating temperature.**

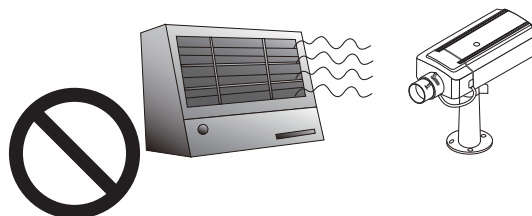

- **Keep the Network Camera away from direct sunlight.**

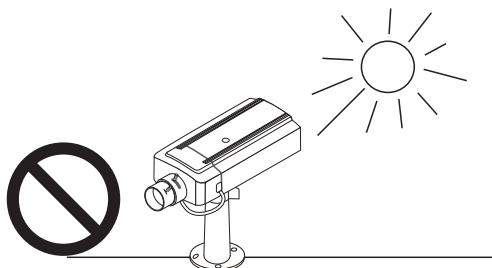

- **Do not place the Network Camera in high humid environments.**

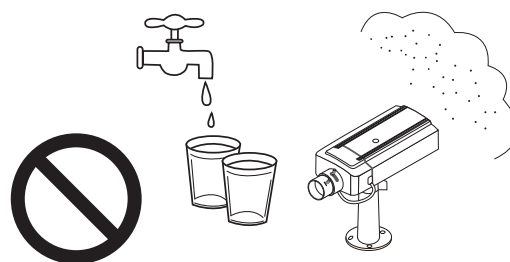

- **Do not place the Network Camera on unsteady surfaces.**

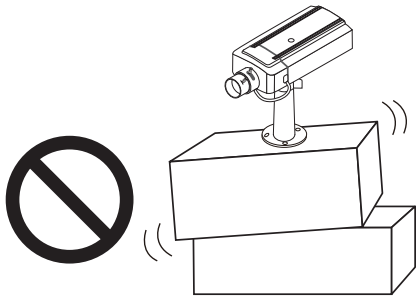

- **Do not touch the Network Camera when it's lightning.**

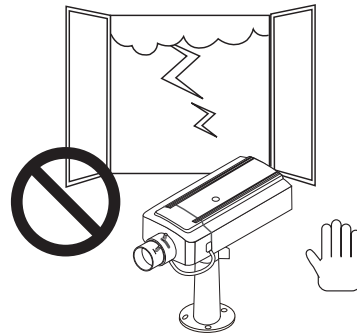

- **Do not disassemble the Network Camera.**

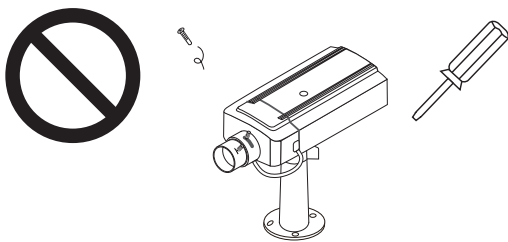

- **Do not drop the Network Camera.**

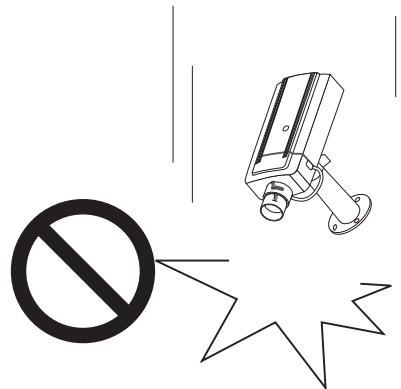

- **Do not insert any object into the Network Camera, such as needles.**

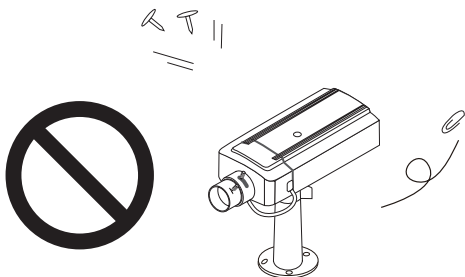

1 Check Package Contents

- IP7151 / IP7152

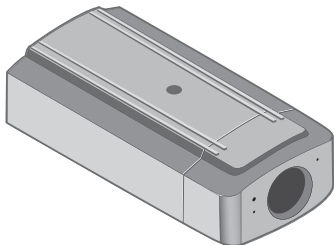

- Power adapter

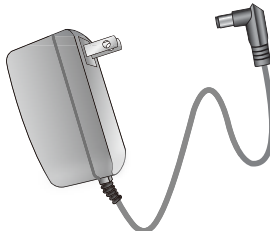

- Camera stand

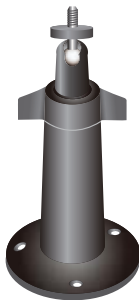

- Lens

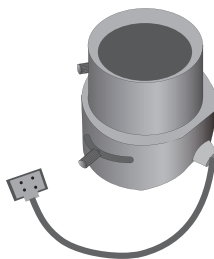

- Quick installation guide



- Software CD



- Warranty card



- Antenna (IP7152 only)

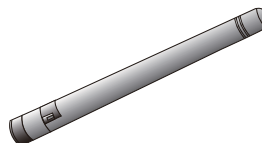

2 Physical Description

● Front panel

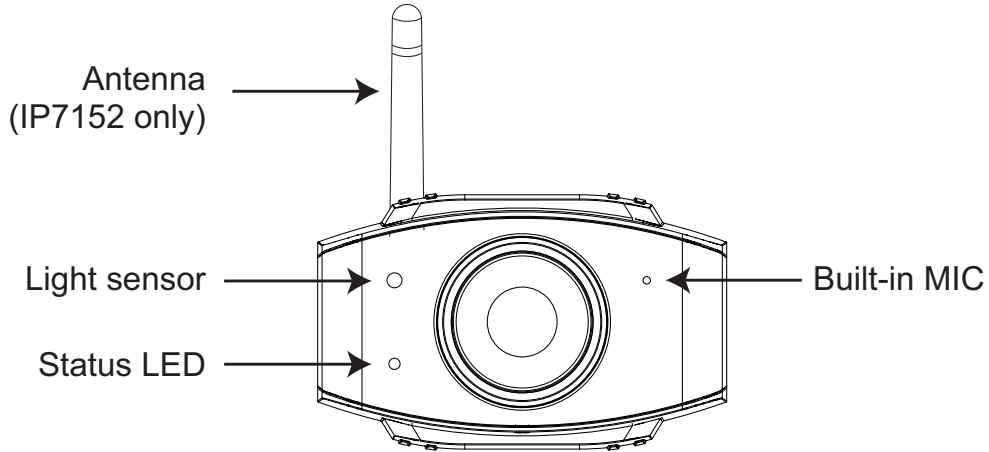

● Back panel

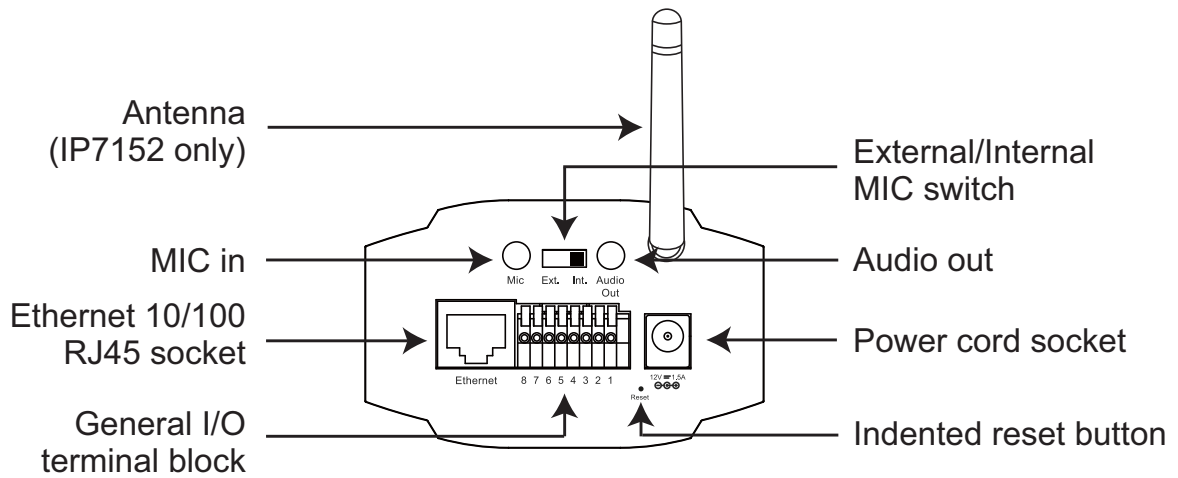

● Lens

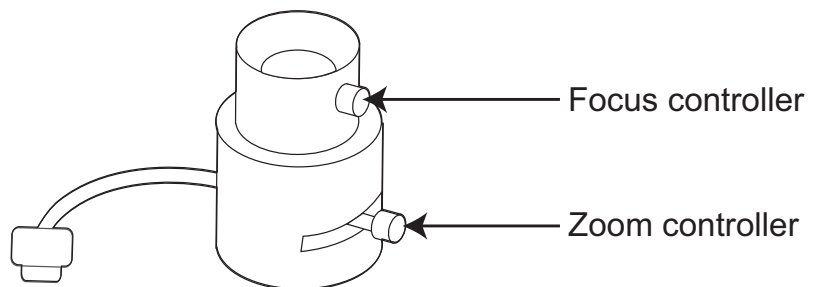

3 Mounting the Lens to the Camera

1. Mount the lens by turning it clockwise onto the camera mount until it stops. If necessary, turn the lens counterclockwise slowly until it gets the best attitude.
2. Connect the lens cable plug to the camera connector.
3. Unscrew the zoom controller to adjust the zoom factor. Upon completion, tighten the zoom controller.
4. Unscrew the focus controller to adjust the focus range. Upon completion, tighten the focus controller.

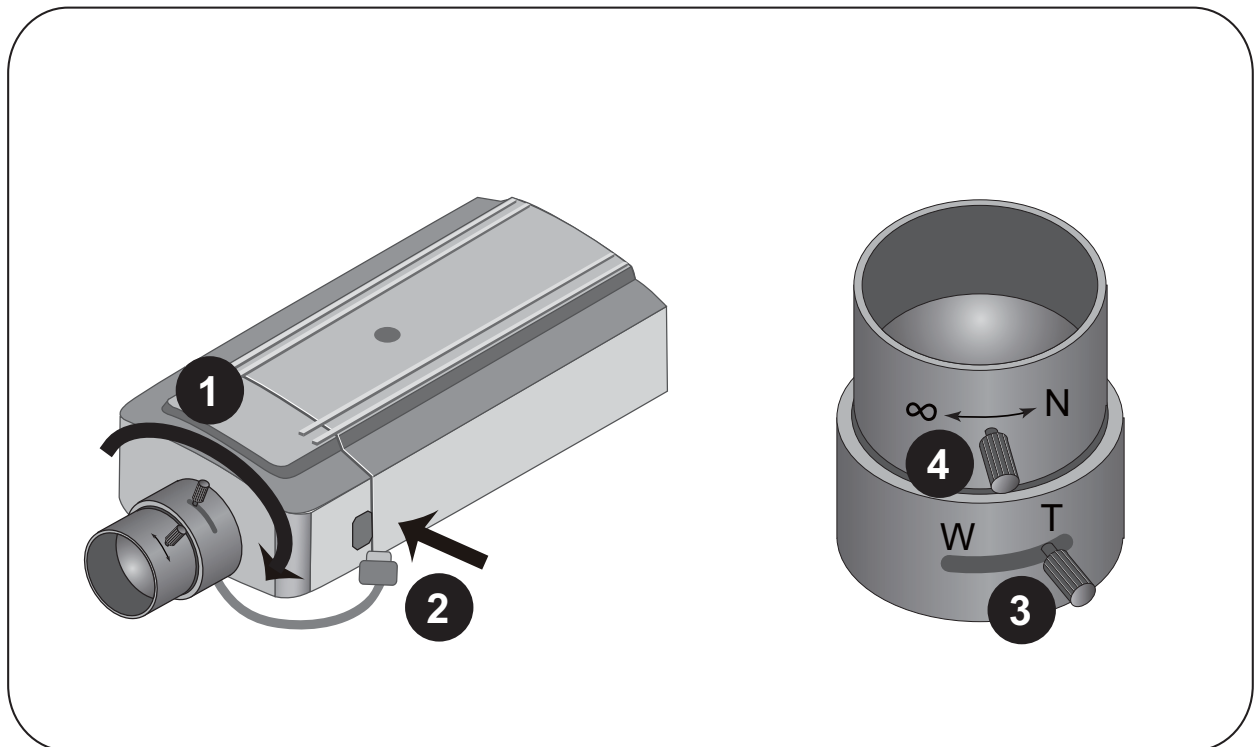

For further setup, please refer to the lens' instruction manual inside the lens package.

4 Network Deployment

General Connection (without PoE)

1. Connect the camera to a hub via Ethernet cable.
2. Connect the supplied power cable from the camera to a power outlet.

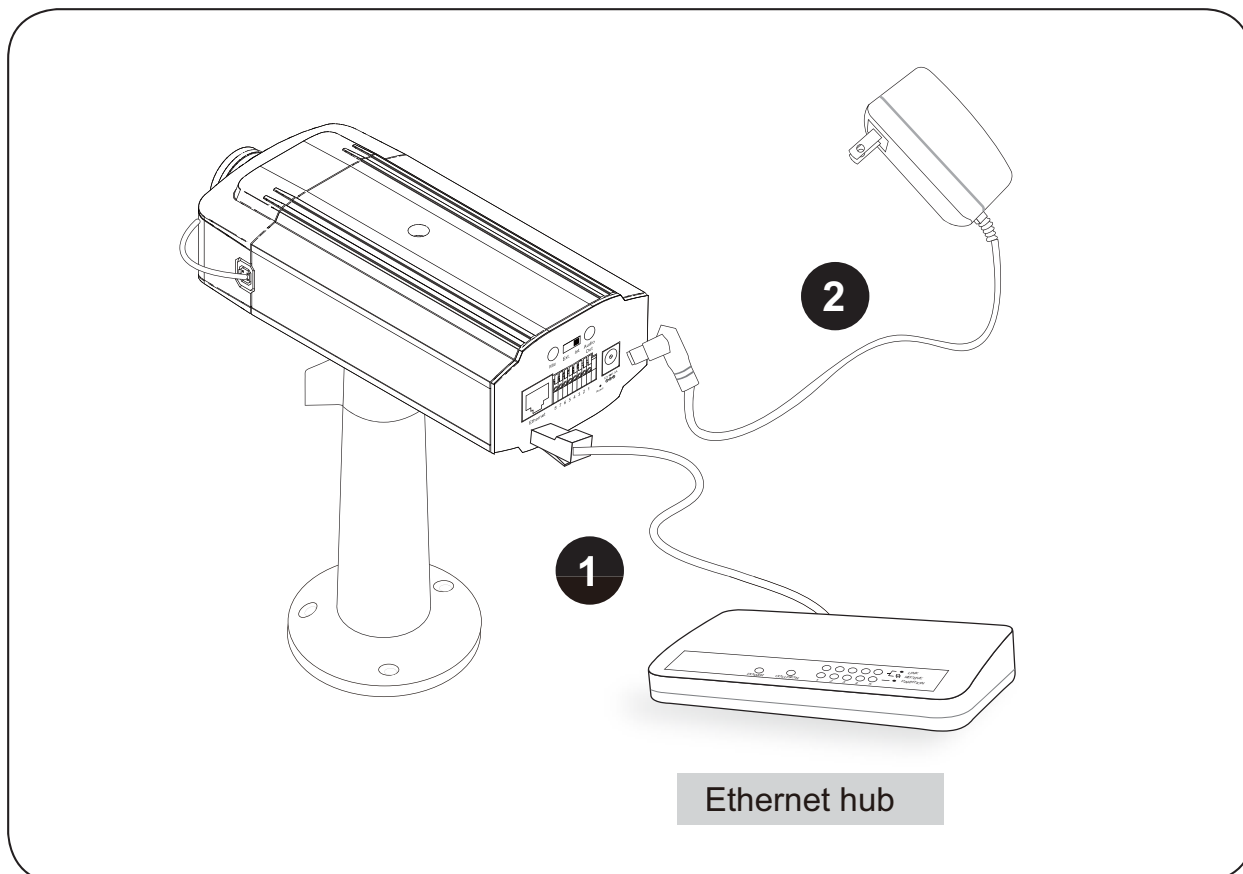

Power over Ethernet (PoE) (IP7151 only)

● **When using a PoE-enabled hub**

The camera is PoE-compliant, allowing transmission of power and data via single Ethernet cable. See the following illustration to connect the camera to a PoE-enabled hub via Ethernet cable.

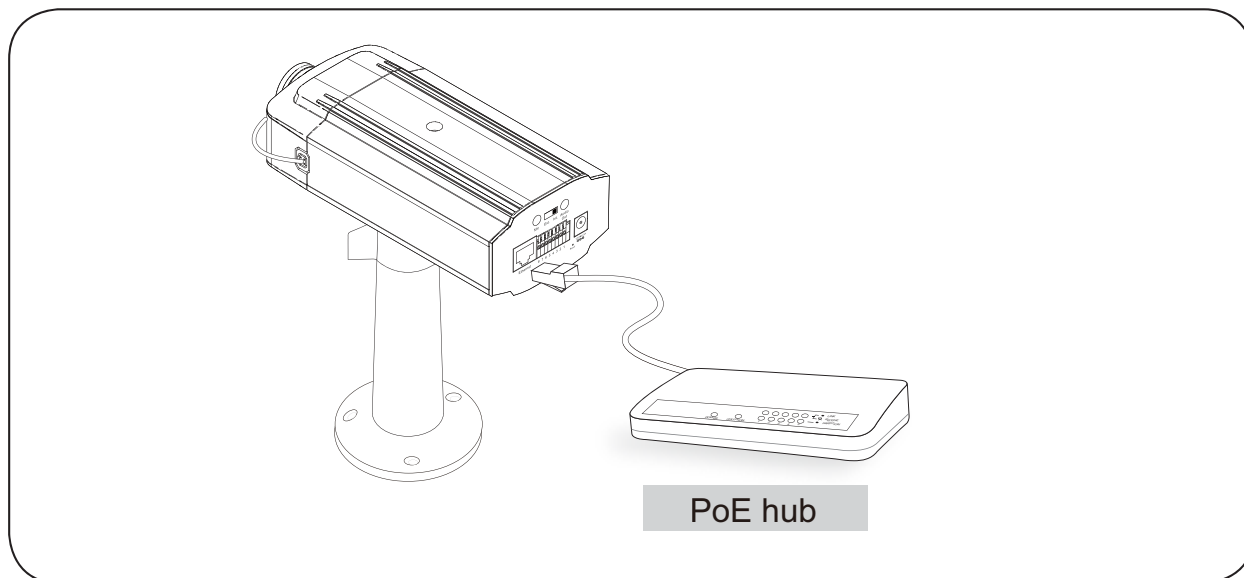

● **When using a non-PoE hub**

Use a PoE power injector (optional) to connect between the camera and a non-PoE hub.

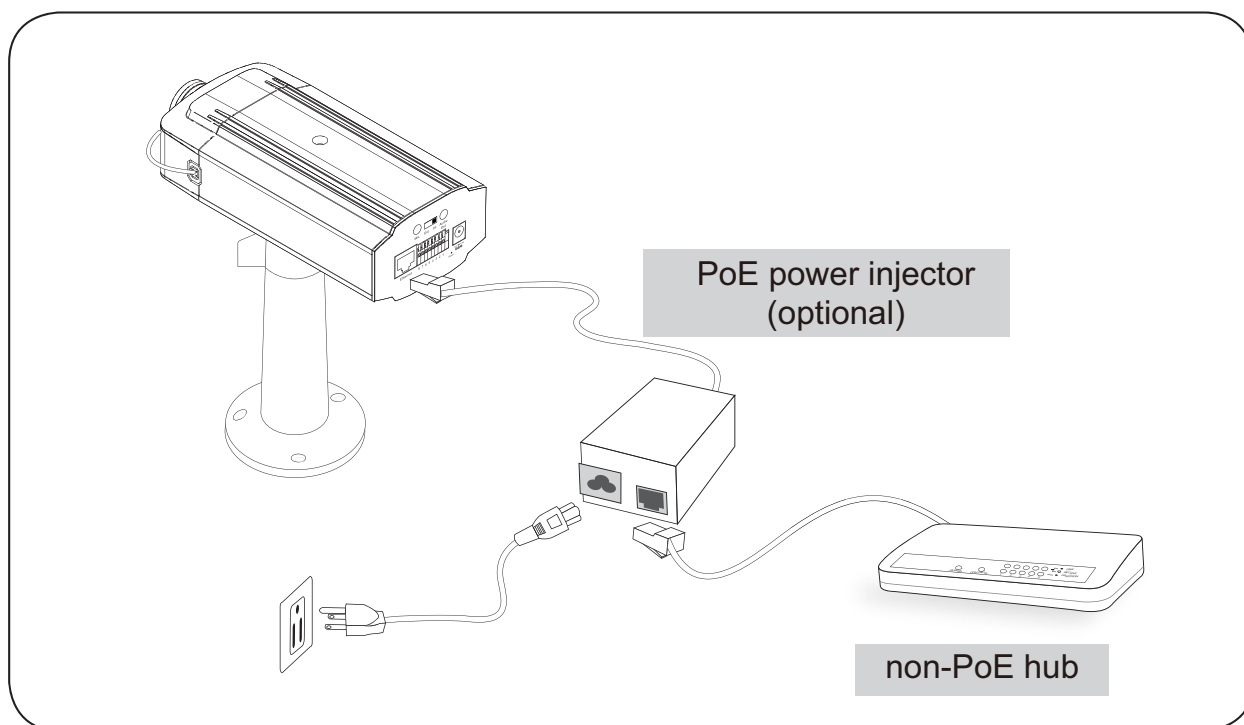

5 Assigning IP Address

1. Run the "Installation Wizard 2" under the Software Utility directory from software CD.
2. The program will conduct analyses on your network environment. After your network is analyzed, please click on the "Next" button to continue the program.



3. The program will search the Vivotek Video Receivers, Video Servers or Network Cameras on the same LAN.
4. After searching, the main installer window will pop up. Click on the MAC that matches the one labeled on the bottom of your device to connect the Internet Explorer to the Network Camera.

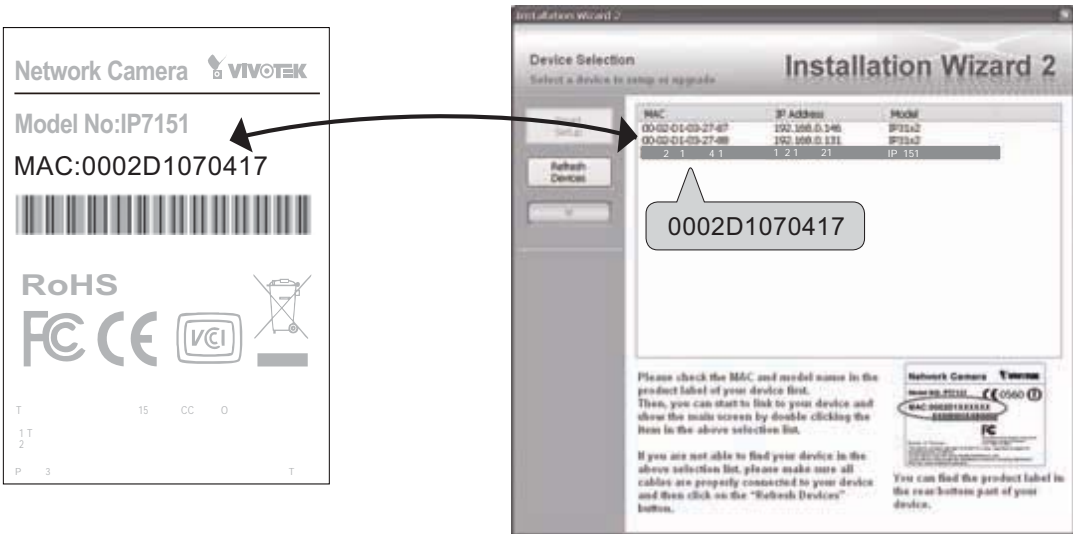

6 Retrieving Images



For further setup, please refer to user's manual on the software CD.

7

Configure the Wireless Connection (IP7152 only)

1. Check the SSID currently set on your wireless access point (AP).
2. Go to IP7152's Configuration > Wireless LAN.

3. Type in the SSID consistent with the setting on your AP.

4. Select the Wireless mode as "Infrastructure".

5. Click Save.

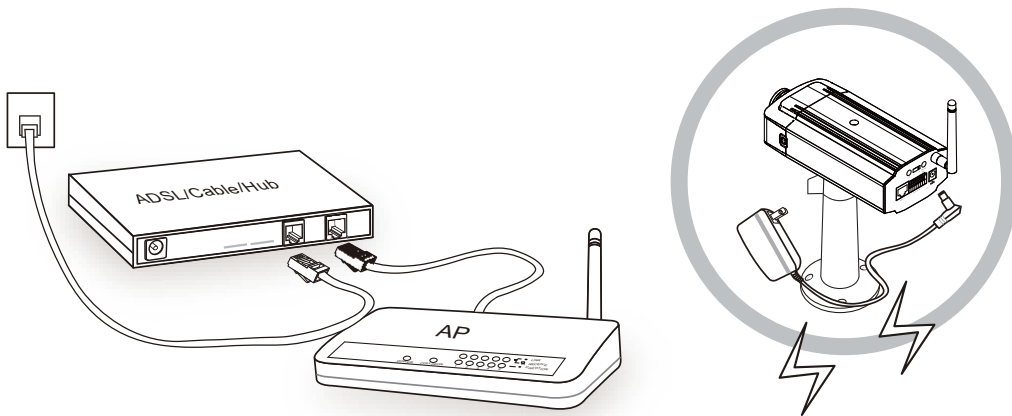
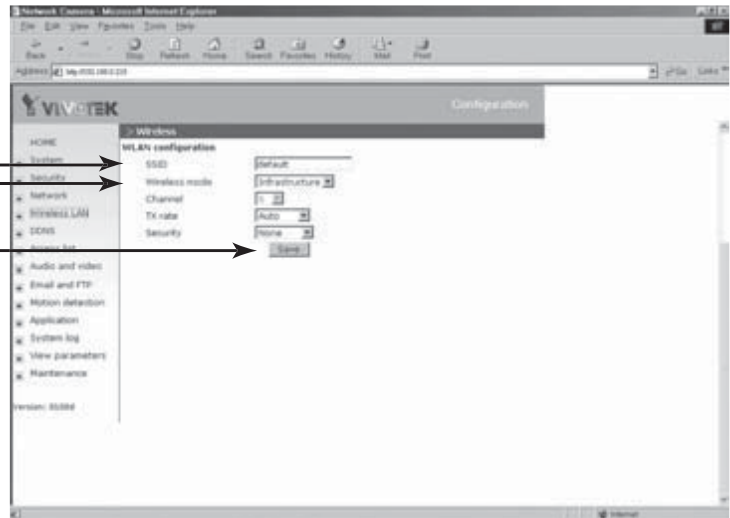

Note:

1. SSID, abbreviated from Service Set Identifier, is the name assigned to the wireless network. The IP7152's factory SSID setting is set to "default".
2. Select "Ad-Hoc" wireless mode if you want the IP7152 to communicate without using an AP or wireless router.

For further setup, please refer to user's manual on the software CD.